

## SPICE thermal model

BUK764R0-75C

Symbol	Parameter	Conditions	Min	Typ	Max	Unit
$R_{th(j-mb)}$	thermal resistance from junction to mounting base		-	-	0.49	K/W

$C_{th1}$	9.100E-02 F
$C_{th2}$	1.600E-02 F
$C_{th3}$	4.002E-03 F
$C_{th4}$	1.023E-03 F
$C_{th5}$	2.617E-04 F
$C_{th6}$	6.690E-05 F
$C_{th7}$	1.711E-05 F
$C_{th8}$	4.374E-06 F
$R_{th1}$	3.290E-01 $\Omega$
$R_{th2}$	1.210E-01 $\Omega$
$R_{th3}$	3.000E-02 $\Omega$
$R_{th4}$	7.379E-03 $\Omega$
$R_{th5}$	1.822E-03 $\Omega$
$R_{th6}$	4.499E-04 $\Omega$
$R_{th7}$	1.111E-04 $\Omega$
$R_{th8}$	2.744E-05 $\Omega$

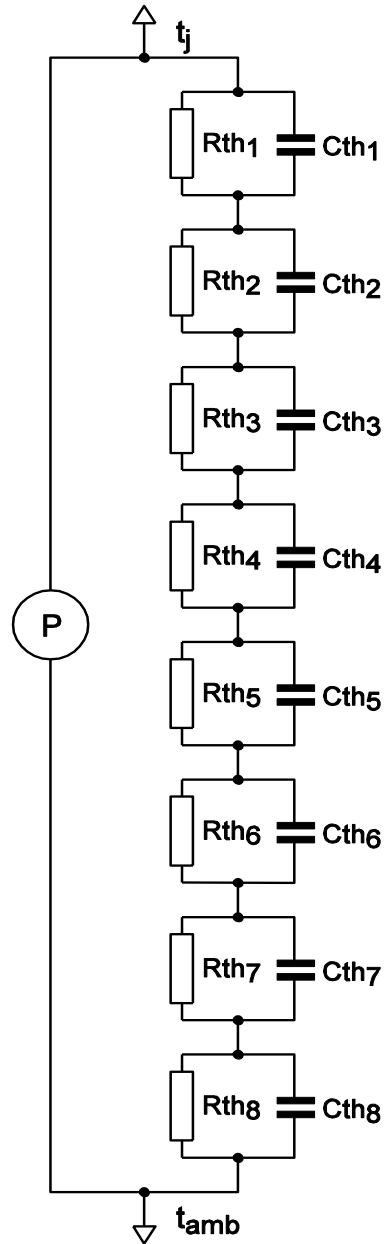

001aal768

Part: BUK764R0-75C  
 Version: 1  
 Date: 17-9-2010  
 Rth: 0.490614391